

Modulating Water Valves and Bulb Wells

APPLICATION: These modulating valves regulate the flow of water to the heat exchanger to maintain a desired exiting oil temperature. They open automatically when temperature increases at the sensing bulb. **No** external power source is required to actuate the valve. **Not to be** used for salt water service.

ADJUSTMENT: 1/2" to 1 1/4" valves can be adjusted with a screwdriver, 1 1/2" and 2" have a 1/2" square shaft. Turn the adjusting screw clockwise to **decrease** opening temperature; and counterclockwise to **increase** opening temperature. Valves are not calibrated, so final desired temperature setting must be established experimentally. Valve is fully open 36°F above opening point.

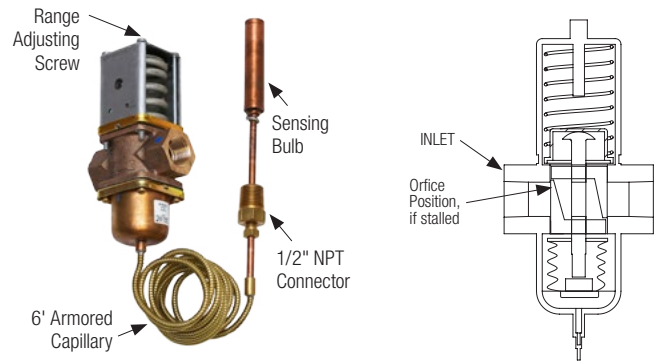

Part Number	Water Valves				Bulb Well Recommended Size
	Pipe Size (NPT)	Range (Opening Point)	Sensing Bulb Size Diameter X Length	Maximum Water Flow	
65293	1/2"	115°F to 180°F	11/16" x 3 3/4"	25 GPM	65140
65127	3/4"	115°F to 180°F	11/16" x 3 3/4"	40 GPM	65140
65128	1"	115°F to 180°F	11/16" x 6"	55 GPM	65141
65146	1 1/4"	115°F to 180°F	11/16" x 6"	75 GPM	65141
65511	1/2"	75°F to 135°F	11/16" x 10"	25 GPM	65380
65253	3/4"	75°F to 135°F	11/16" x 10"	40 GPM	65380
65254	1"	75°F to 135°F	11/16" x 16 1/4"	55 GPM	67438
65255	1 1/4"	75°F to 135°F	11/16" x 16 1/4"	75 GPM	67438
66100	1 1/2" ASME	75°F to 135°F	11/16" x 16 1/4"	90 GPM	67438
67173	2" ASME	75°F to 115°F	11/16" x 43"	150 GPM	67808

Working pressure to 150 PSI Maximum. *For additional protection of the bulb well stem, use the next longer bulb well.

Water Valves

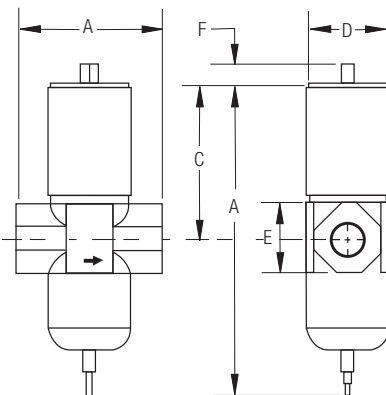

Valve Size	Dimensions (Inches)						Approximate Shipping Weight (LBS)
	A	B	C	D	E	F	
1/2"	3/4	7	3 3/8	1 7/32	1 1/2	1 1/2	4.3
3/4"	3 1/16	7 29/64	3 51/64	2 1/32	1 3/4	1 3/2	5.8
1"	4 27/32	10 13/16	5 31/64	2 5/8	2	1/2	10
1-1/4"	4 59/64	10 37/64	5 49/64	2 5/8	2 3/8	1/2	12
1-1/2"	5 1/16	10 37/64	5 49/64	2 5/8	See Flange below	1/2	18
2"	6 3/8	12 33/64	6 15/32	3 1/2		1/2	27

Valve Size	Flange Specifications (Inches)			
	Number of Bolt Holes	Bolt Hole size	Bolt Circle	Flange Diameter
1/2"	4	5/8	3 3/8	5
2"	4	5/8	4 3/4	6

Standard temperature elements are furnished with 6' capillary. Longer capillary lengths not available. Valve Disc: Buna N in brass disc retainer.

Modulating Water Valves and Bulb Wells

Bulb Wells

Bulb Well Part Number	Dimensions In Inches		Approximate Shipping Weight (LBS)	Materials
	A	B		
65140	4 ¹⁵ / ₃₂ "	3 ¹⁵ / ₃₂ "	1	Tube: Copper Fitting: Brass
65141	7 ¹ / ₃₂ "	6 ⁷ / ₃₂ "	1	
65280	11 ⁷ / ₃₂ "	10 ⁷ / ₃₂ "	1	
67438	17 ¹⁵ / ₃₂ "	16 ¹⁵ / ₃₂ "	1	
67808	44 ³ / ₈ "	43 ³ / ₈ "	1	

Custom Bulb Well lengths available. Consult factory for additional information.

Water Valve Part Number	By-Pass Orifice Diameter	Maximum Bulb Temperature °F	Opening Temperature (Factory Setting) °F
65293	.062"	200	135
65127	.062"	200	135
65128	.093"	200	135
65146	.093"	200	135
65511	.062"	150	103

Water Valve Part Number	By-Pass Orifice Diameter	Maximum Bulb Temperature °F	Opening Temperature (Factory Setting) °F
65253	.062"	200	135
65254	.062"	200	135
65255	.093"	200	135
66100	.093"	200	135
67173	.125"	155	103

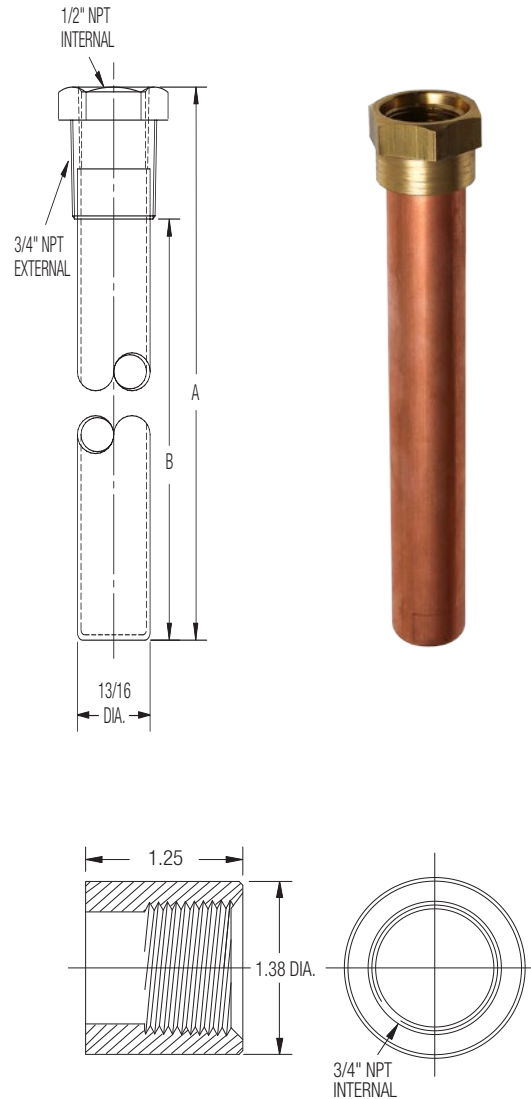

65187 Half Coupling - Mount to Reservoir. For use with all bulb wells shown above.

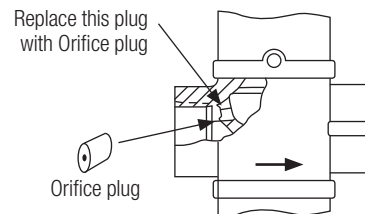

All stock valves are supplied with a drilled and tapped internal by-pass in the regulator body. A solid plug is installed in this hole for 100% shut-off. A drilled orifice plug is packed in an envelope with each valve for field installation, if continuous minimum flow is required.

Thermal Bypass Assembly

This thermal bypass valve is ideally suited for hydrostatic drive circuits which require fast warm-up, controlled fluid temperature, and low return line back pressure. When installed in the return line of a hydraulic circuit that employs an oil cooler, this device will modulate fluid temperature by either shifting return line flow through the cooler, or bypassing directly to the reservoir. In addition, a built-in pressure relief function automatically relieves excess pressure to the reservoir should the cooler become restricted and resultant pressure drop become too high for the cooler circuit.

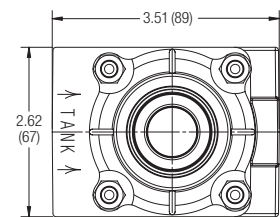
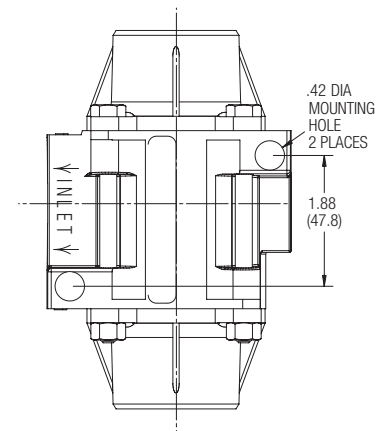
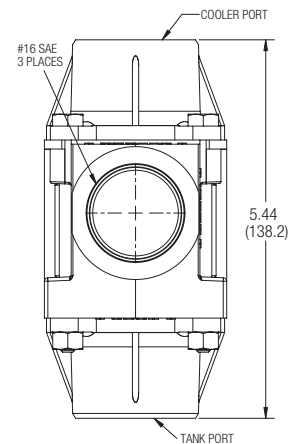

Standard Shift Temperatures

100°F (38°C) 120°F (49°C) 140°F (60°C) 160°F (71°C)

Full Shift (Cooler Port Open) Temperatures

Shift temperature plus 25°F (14°C)

Relief Valve Setting 65 PSI (4.5 BAR) *Consult factory for other pressure settings.*

Maximum Operating Pressure 250 PSI (17 BAR)

Proof Pressure 300 PSI (21 BAR)

Minimum Burst Pressure

Up to the full shift temperature: 325 PSI (22 BAR).

Above the full shift temperature: 600 PSI (41 BAR).

Minimum Operating Temperature -30°F (-34°C)

Maximum Operating Temperature Shift temperature plus 75°F (24°C)

Maximum Flow Rating 60 GPM (227 l/m)

Leakage @ 250 PSI (17 BAR) and 60 GPM (227 l/m) Inlet Flow

Cooler Port:

- 0.5 GPM (2 l/m) maximum up to 5°F (3°C) before shift temp.
- 1.0 GPM (4 l/m) maximum from 5°F (3°C) before shift to shift.

Tank Port: 0.10 GPM (0.4 l/m) maximum

Operating Fluid Mineral base hydraulic fluids

Construction Aluminum die-cast housing

Operating Characteristics

- Mode 1: At temperatures below the shift temperature oil flows from inlet to tank port.
- Mode 2: At temperatures between the start of shift and full shift the flow from the inlet port is divided between the cooler and tank ports.
- Mode 3: At temperatures above the full shift temperature inlet flow is through the cooler port.
- Mode 4: At temperatures above the full shift temperature the excess pressure is relieved through the tank port.

For 120°F Shift Temperature

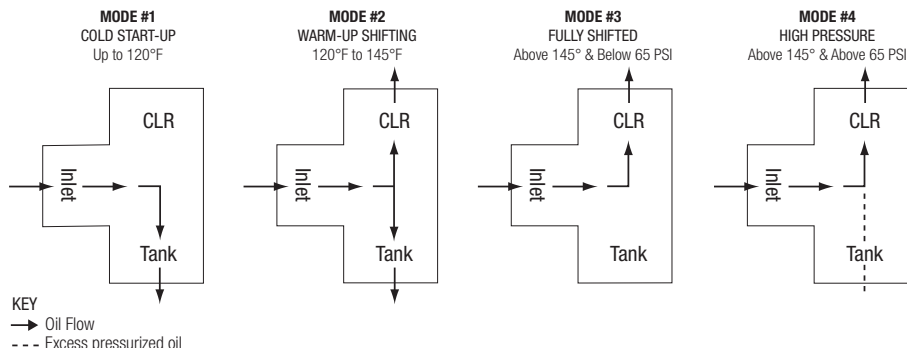

NOTE: If the temperature drops below 145°F the valve will shift back to modes 2 or 1.

Graphic Symbol

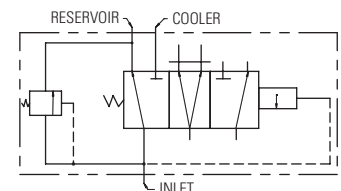

Thermal Bypass Assembly

Pressure Drop (Mobile DTE 26 OIL)

Inlet Port Thru Tank Port
@ 100°F (38°C) (300 SUS)

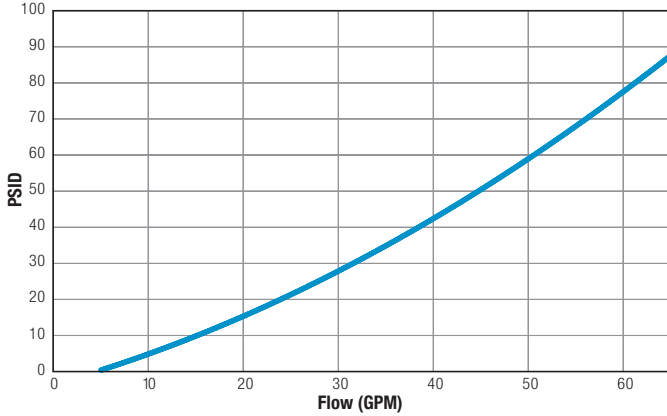

Inlet Port Over Integral Relief Valve
@ 170°F (77°C) (78 SUS)

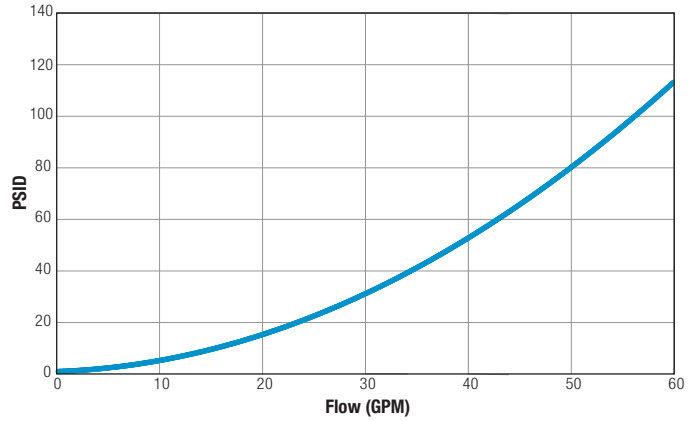

Inlet Port Thru Cooler Port
@ 145°F (63°C) (110 SUS)

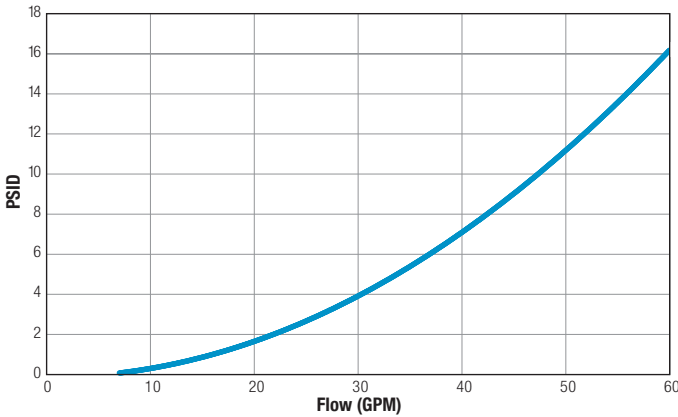

NOTE: Pressure drop shown is added to relief valve crack pressure for total pressure drop.

Part Number	Shift Temperature
65654	100°F (38°C)
65655	120°F (49°C)
65656	140°F (60°C)
65657	160°F (71°C)

How to Order Consult factory for pricing and lead time

- - Thermal Bypass Assembly

Part Number

Pressure Setting
65 = Standard, 65 PSI
Optional pressure settings available in 5 PSI increments, up to 85 PSI.

Three-Way Thermostatic Valves

1/2", 3/4", 1", 1 1/2" & 2" NPT Ports*

- Self-contained
- Wide range of temperatures
- Rugged construction
- Non-adjustable
- Heavy duty
- Operate in any position
- Tamper-proof
- Replaceable element
- Compact



Materials

Housing Grey iron (steel or bronze optional)
125 PSI maximum operating pressure

O-Ring Seals Viton (Buna N optional)

*3", 4" and 6" Flange Models also available.

Operation

TTP thermostatic valves use the principle of expanding wax. A self-contained power element activates a stainless steel sliding valve that provides a positive three-way valve action. All temperature settings are factory set. Elements are field replaceable to obtain the same, or a new bypass temperature setting.

On starting, total flow is in the bypass mode. As the fluid temperature rises, some fluid is diverted to the cooling system. As fluid temperature continues to rise, more flow is diverted until the valve is fully stroked. At this point, all the flow is diverted to the cooler. With respect to temperature ranges, the "nominal" temperature represents the "operating temperature."

Valves are acceptable for oil or water service.

Applications

Three Way Thermostatic Valves may be installed for either mixing or diverting modes of operation at the preference of the user. They may be mounted in any plane.

When installed as a mixing valve, it is on the cold side of the application, and mixes hot liquid with cooled liquid to discharge the proper temperature fluid to the process.

When installed as a diverting valve, it is on the hot side of the application, and bypasses the cold liquid allowing the system to warm up, then directs the hot liquid to the cooler.

Temperature settings are nominal. 110°F and 140°F are standard. Other settings are available upon request. The valves begin to "shift" (open) about 10°F below the nominal temperature setting and are fully shifted about 10°F above.

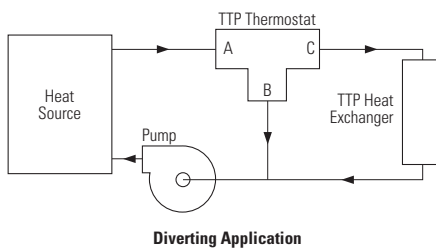
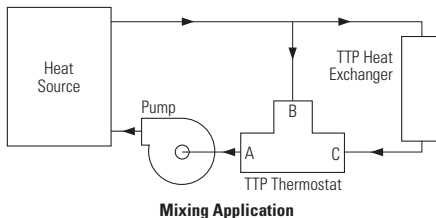

Typical Installation

Hydraulic Power Units Diverting mode 110°F

Air Compressors Mixing mode 140°F

Mobile Oil Coolers Diverting mode 110°F

Radiators Diverting mode 190°F

Three-Way Thermostatic Valves

Pressure Drop Curves

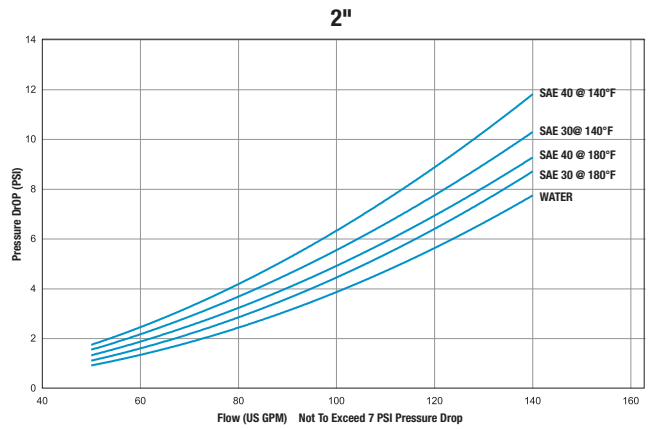
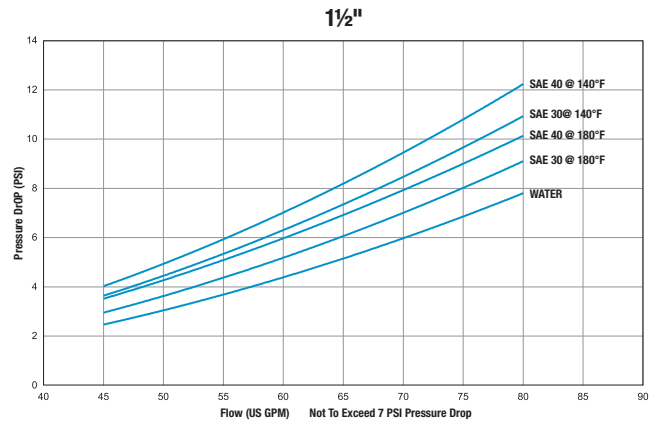
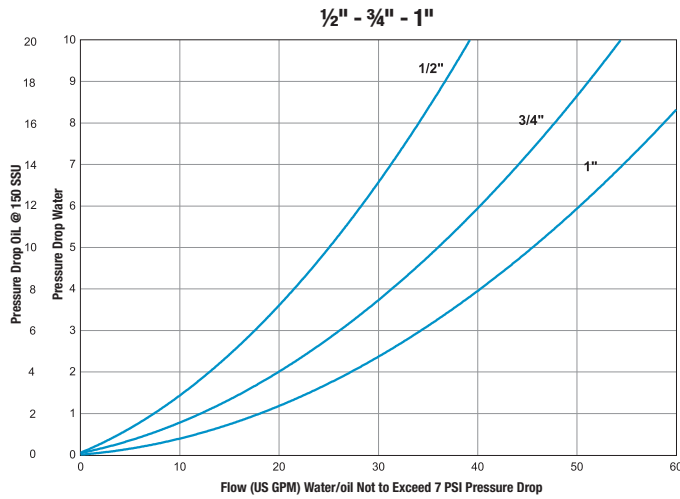

Dimensions and Part Numbers

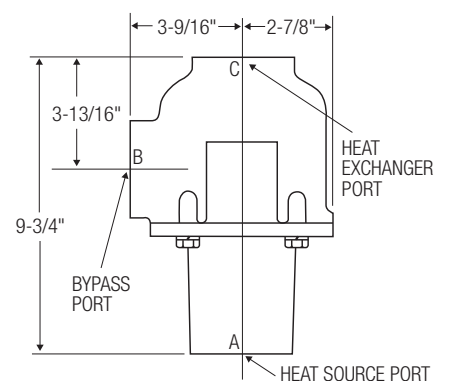
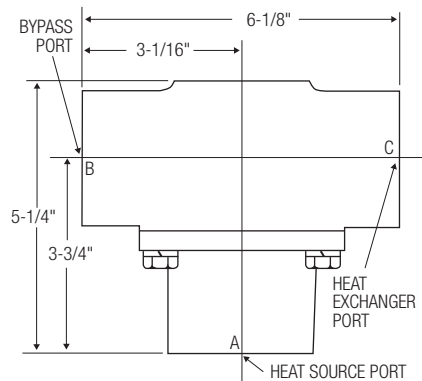
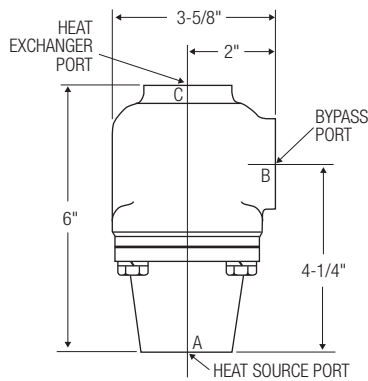

Port Size	Part Number
1/2" NPT	66037-110°F
1/2" NPT	66037-140°F
3/4" NPT	66038-110°F
3/4" NPT	66038-140°F
1" NPT	66039-110°F
1" NPT	66039-140°F
#16 SAE	67365-110°F
#16 SAE	67365-140°F

Port Size	Part Number
1 1/2" NPT	66040-110°F
1 1/2" NPT	66040-140°F
#24 SAE	67760-110°F

Port Size	Part Number
2" NPT	66041-105°F
2" NPT	66041-140°F

NOTE: All three ports on any one valve have the same thread size.

Three-Way Thermostatic Valves

Special Temperature Ranges

½" - ¾" - 1" NPT Part Numbers	1½" NPT Part Numbers	2" NPT Part Numbers
65974	65977	65978
65975	66040	66041
65976	67760	
66037	(#24 SAE)	
66038		
66039		
67365		
(#16 SAE)		

½" - ¾" - 1" NPT		1½" NPT		2" NPT	
Nominal	Temperature Range (°F)	Nominal	Temperature Range (°F)	Nominal	Temperature Range (°F)
80	77-88	80	70-88	75	70-85
90	80-100	90	80-100	90	85-105
110	100-120	110	100-120	105	100-116
120	110-130	120	110-130	120	110-130
130	120-140	130	120-140	130	124-140
140	130-150	140	130-150	140	135-150
150	140-160	150	140-160	150	145-160
160	150-170	160	150-170	155	150-165
170	163-180	170	163-180	160	155-172
185	175-190	175	170-185	165	160-175
195	185-200	180	175-190	170	165-180
200	190-210	190	185-200	180	175-190
		200	190-210	195	188-208
				210	200-215

EXAMPLE: 1" NPT, Part Number 66039-90 indicates the 1" NPT valve with a nominal shift temperature of 90°F. The actual operating temperature range in this example is 80-100°F. The valve begins to open at 80°F, and is fully open at 100°F.

How to Order Consult factory for pricing and lead time

					-				°F
Valve Part Number						Nominal Temperature Setting			

Forged Brass Y-Strainer

- Suitable for 600 WPG service, 150 PSI WSP, with easy clean plug
- MSS SP-110 approved
- Temperature range: -10°F to 250°F
- Heavy duty forged brass construction
- Screwed caps are straight threaded with PTFE gaskets
- 304 Stainless steel 50 mesh screen ¼" - 1"
- 304 Stainless steel 20 mesh screen 1¼" - 2"
- Threaded ends comply with ANSI.B2.1
- Female X female connection

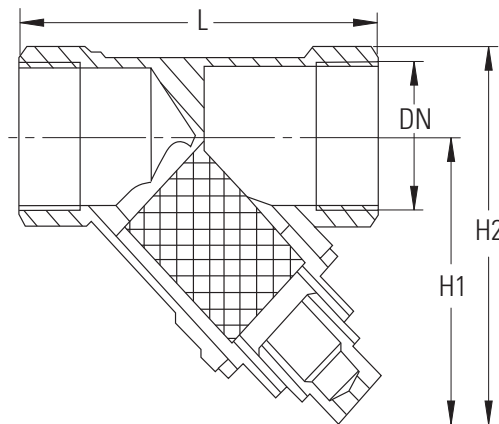

Part Number	DN (NPT)	L	H1	H2	Weight (LBS)
56944	¼	1.97	1.50	1.90	0.22
65294	⅜	1.97	1.50	1.90	0.21
65295	½	2.36	1.97	2.44	0.38
65296	¾	2.76	2.09	2.68	0.57
65297	1	2.95	2.24	2.95	0.9
65301	1¼	3.54	2.76	3.74	1.3
65302	1½	4.09	2.99	4.17	1.81
65303	2	4.72	3.35	4.96	3.31

All dimensions in inches, unless noted otherwise.